

EH SERIES ELECTRONIC RECORDING ALARM



COMMON SETTING ALARM

MODEL EH □ 26 - □ □ (High or low limit alarm)
EH □ 36 - □ □ (High and low limit alarm)

The EH series features one pen continuous writing or up to twelve point recording systems. These recorders include high and low limit alarms with an accuracy of $\pm 0.5\%$ of the input span.

MODEL

EH□26 - □□
EH□36 - □□

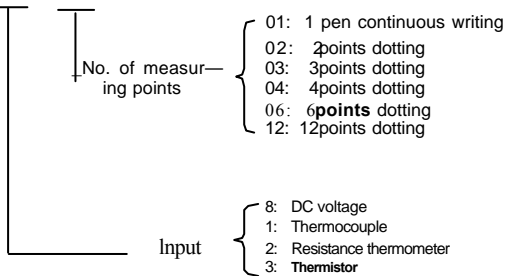

GENERAL SPECIFICATIONS

CASING: Front door..... Diecast aluminum
Rear case Steel plate
COATING: Door..... Black (Munsell N1.5)
Case..... Metallic silver
MOUNTING: Flush panelmount
Backward tilting up to 300 is possible. (Dotting type and one pen type with cartridge pen only)
WEIGHT: About 13.5kg

INPUT SIGNAL:
 mV ————— 3mV to 500mVDC span
 1mV to 3mVDC span*
 500mV to 100VDC span*
 Thermocouple — K, E, J, T ... More than 100°C span
 R..... More than 450°C span
 B..... More than 1000°C span
 S..... More than 500°C span
 Resistance thermometer More than 30°C span (Pt 100Ω)
 Thermistor — Lower than 250°C ... More than 30°C span
 250 to 300°C..... More than 40°C span

SCALE LENGTH: 180mm
INDICATING ACCURACY:
 mV input $\pm 0.25\%$ of input span
 Thermocouple, resistance thermometer, thermistor
 $\pm 0.5\%$ of input span
DEAD BAND: 0.1% of input span
BALANCING SPEED: About 2.0 sec. (50Hz) or about 1.6 sec.
 (60Hz) for input span traveling
CHART: Fanfold chart
 Effective recording width 180mm (Total width
 200mm)
 Total length 20m

RECORDING POINTS: 1, 2, 3, 4, 6 or 12 points
RECORDING SYSTEM:
 Pen-writing type..... One-point continuous recording (ink pen or cartridge pen*)
 Dotting type..... 2, 3, 4, 6, or 12 points ink pad dotting using a different color at each point
 2 points 1 Red, 2 Black
 3 points 1 Red, 2 Black, 3 Sky blue
 4 points 1 Red, 2 Black, 3 Sky blue, 4 Green
 6 points 1 Red, 2 Black, 3 Sky blue, 4 Green, 5 Brown, 6 Purple
 12 points 1 Red, 2 Black, 3 Sky blue, 4 Green, 5 Brown, 6 Purple, 7 Orange, 8 Gray, 9 Blue, 10 Greenish brown, 11 Scarlet, 12 Violet
CHART SPEED: 12.5, 25, 50, 100mm/h and FAST
DOTTING INTERVAL: 6 sec. (50Hz) or 5 sec. (60Hz)
PEN LIFT (Pen-writing type): Manual

ALARM SETTING ACCURACY: $\pm 0.5\%$ of input span
ALARM SYSTEM:
 High (low) limit (1 setting index), or high and low limits (2 setting indexes)
ALARM DEAD BAND: 0.6% of input span
CONTACT CAPACITY (Alarm): 100VAC 1A, 200VAC 0.5A
POWER SUPPLY:
 100, 110, 120, 130, 200, 220, 230 or 240VAC, 50Hz or 60Hz
ALLOWABLE VOLTAGE FLUCTUATION:
 (+) 10% to (-) 10% of rated value
WORKING TEMPERATURE: (-) 10°C to 50°C
WORKING HUMIDITY: 30 to 90%RH
ALLOWABLE SIGNAL SOURCE RESISTANCE:
 mV input 1mV \leq Span voltage \leq 500mV Less than 10kΩ
 500mV < Span voltage \leq 100V Less than 1kΩ
 Thermocouple input Less than 10kΩ
 (With burn-out circuit* Less than 150Ω)
 Resistance thermometer input Less than 10Ω per wire
INPUT RESISTANCE:

mV input 1mV \leq Span voltage \leq 500mV About 8MΩ
 500mV < Span voltage \leq 100V About 1MΩ
 Thermocouple input About 8MΩ
MAXIMUM COMMON MODE VOLTAGE: 250VAC
COMMON MODE REJECTION RATIO: More than 150dB
SERIES MODE REJECTION RATIO: More than 50dB
INSULATION RESISTANCE:
 500VDC, 20MΩ or more between measuring terminals and protective conductor terminal
 1000VDC, 20MΩ or more between power terminals and protective conductor terminal
 1000VDC, 20MΩ or more between measuring terminals and power terminals
WITHSTAND VOLTAGE:
 500VAC, 1 mm. between measuring terminals and protective conductor terminal
 1000VAC (100V line)/1500VAC (200V line), 1 mm. between power terminals and protective conductor terminal
 1000VAC (100V line)/1500VAC (200V line), 1 mm. between measuring terminals and power terminals
ILLUMINATION: Fluorescent lamp
POWER CONSUMPTION: About 24VA

* Option

**24-POINT RECORDER
WITH ALARM**

- MODEL EH □ □ □ -24S**
(24-POINT RECORDER WITH SELECT OFF FUNCTION)
EH □ □ □ -24N
(24-POINT RECORDER WITHOUT SELECT OFF FUNCTION)
EH □ □ □ -24
(24-POINT RECORDER WITH 12-POINT REPETITIVE PRINTING)

These instruments are designed as EH series electronic self-balancing recorders with a 180mm chart for measuring data at 24 points.

The recording system is divided into two types.

(1) Dotting/numerical printing system which prints dots (12-color coded dot) with the numerical printing of 1 to 24.

(2) Dotting system which divides 24 points into 2 groups and identifies these groups from each other using indicator lamps with 12-color coded dot repetition.

The dotting/numerical printing system can be provided or not provided with the select-off function which permits selectively printing desired measuring points only, while skipping undesired points, according to the models.

■ FEATURES

● INSTRUMENT WITH SELECT-OFF FUNCTION

The instrument permits selectively recording optional points out of 24 points as desired, simply by manipulating the front switch, while skipping undesired measuring points in about 0.5 sec. Thus, it can reduce the dotting intervals with easy identification.

● INSTRUMENT WITHOUT SELECT-OFF FUNCTION

The instrument records 24 measuring points by 12-color coded dots and numerical printing of 1 to 24. Thus, it can easily read recording results. The digital



MODEL EH100 - 24S

printing intervals can be changed by simple lever operation.

● INSTRUMENT WITH 12-POINT REPETITIVE PRINTING

Repetitive 12-color coded dotting is executed by dividing 24 points into two groups consisting of 1 to 12 points and 13 to 24 points, which are identified with each other by the indicator lamps.

■ MODEL

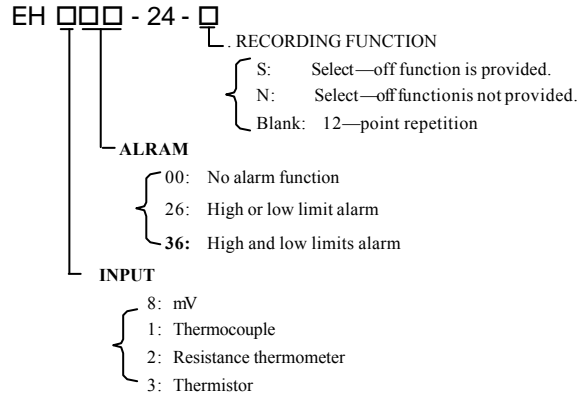

■ CONSTRUCTION

- Recorder with select-off function/without select-off function

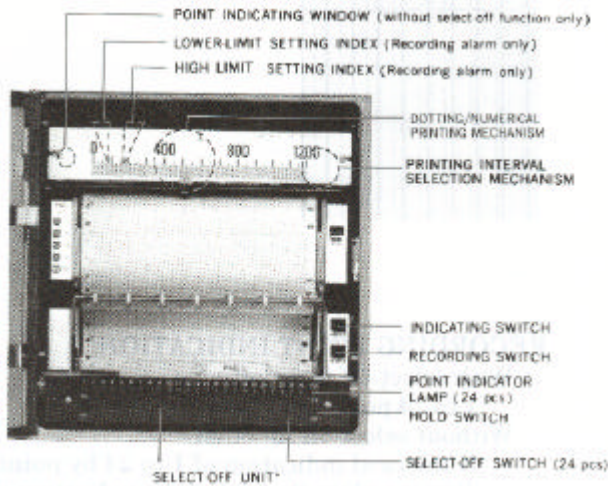

* Equipped for instrument with select-off function only

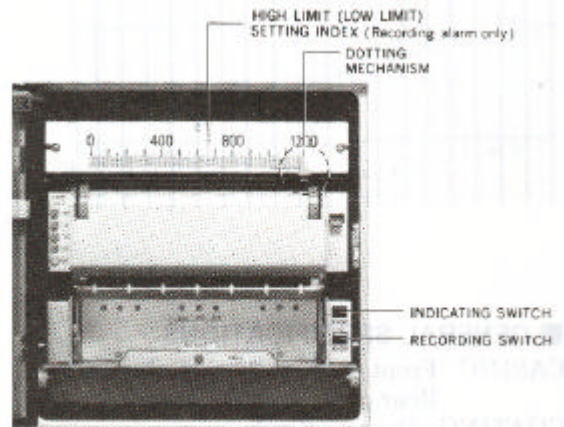

· WITH / WITHOUT SELECT-OFF FUNCTION

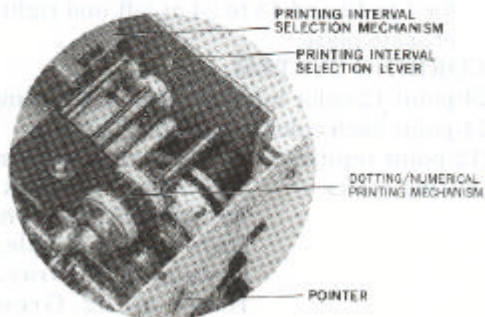

· 12P REPETITION

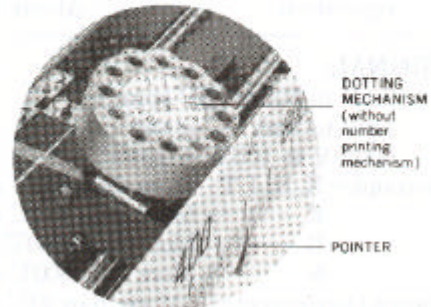

· WITH SELECT-OFF FUNCTION

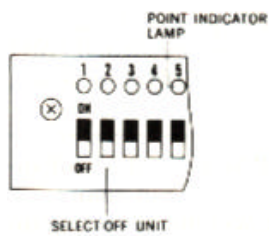

· WITHOUT SELECT-OFF FUNCTION

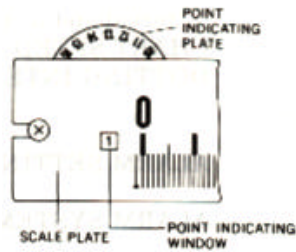

· 12P REPETITION

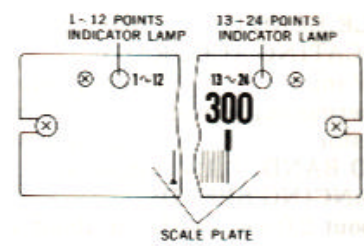

EH SERIES

RECORDING EXAMPLES

- WITH/WITHOUT SELECT-OFF FUNCTION



- 12P REPETITION



GENERAL SPECIFICATIONS

- CASING: Front door..... Diecast aluminum
 Rear case Steel plate
- COATING: Door.....Black
 Case.....Metallic silver
- MOUNTING: Flush panelmount
 Backward tilting up to 30° is possible.
- WEIGHT: With select-off function.....About 16kg
 Without select-off function, 12-points
 repetition.....About 15kg

INPUT SIGNAL:

- MV ——— 3mV to 500mVDC span
 1mV to 3mVDC span*
 500mV to 100VDC span*
- Thermocouple— K, E, J, T. More than 100°C span
 R More than 450°C span
 B More than 1000°C span
 S More than 500°C span
- Resistance thermometer — More than 30°C span
 (Pt 100Ω)
- Thermistor —————
 Lower than 250°C More than 30°C span
 250 to 300°C More than 40°C span

SCALE LENGTH: 180mm

INDICATING ACCURACY:
 mV input ± 0.25% of input span
 Thermocouple, resistance thermometer, thermistor ± 0.5% of input span

DEAD BAND: 0.1% of input span

BALANCING SPEED:
 About 2.0 sec. (50Hz) or about 1.6 sec. (60Hz)
 for input span traveling

CHART: Fanfold chart
 Effective recording width 180mm (Total width 200mm)
 Total length 20m

RECORDING POINTS: 24 points

RECORDING POINT INDICATION:

- With select-off function
 1 to 24 points red lamp indication
- Without select-off function
 Numerical indication of 1 to 24 by point indicating
 plate through point indication window at left side
 of scale plate
 12-point repetition
 Numerical indication of 1 to 12 on dotting
 mechanism and switching indicator lamps
 for 1 to 12 and 13 to 24 at left and right sides
 of scale plate

RECORDING SYSTEM:

- 24-point 12-color ink pad dotting recording and
 24-point each color numerical printing
 (12-point repetition No numerical printing)
- Dotting colors 1/13 Red, 2/14 Black, 3/15
 Sky blue, 4/16 Green, 5/17
 Brown, 6/18 Purple, 7/19
 Orange, 8/20 Gray, 9/21
 Blue, 10/22 Greenish
 brown, 11/23 Scarlet, 12/24
 Violet

NUMERIC PRINTING INTERVAL:

- (Excluding 12-point repetition)
 On each dotting, 25-point interval, 145-point interval
 and no printing, 4 steps switching

CHART SPEED: 12.5, 25, 50, 100mm/h and FAST

DOTTING INTERVAL: 6 sec. (50Hz) or 5 sec.
 (60Hz)

ALARM SETTING ACCURACY: ± 0.5% of input span

ALARM SYSTEM: High (low) limit (1 setting index) or
 high and low limits (2
 setting indexes)

ALARM DEAD BAND: 0.6% of input span

CONTACT CAPACITY (Alarm): 100VAC 1A,
 200VAC 0.5A

POWER SUPPLY: 100, 110, 120, 130, 200, 220,
230 or 240VAC, 50Hz or 60Hz
ALLOWABLE VOLTAGE FLUCTUATION:
(+) 10% to (-) 10% of rated value
WORKING TEMPERATURE: (-) 10°C to 50°C
WORKING HUMIDITY: 30 to 90% RH
ALLOWABLE SIGNAL SOURCE RESISTANCE:
mV input 1mV <= Span voltage <= 500mV Less than 10kΩ
500mV < Span voltage <= 100V Less than 1kΩ
Thermocouple input Less than 10kΩ
(With burn-out circuit* Less than 150Ω)
Resistance thermometer input Less than 10Ω per wire

INPUT RESISTANCE:
mV input 1mV <= Span voltage <= 500mV About 8MΩ
500mV < Span voltage <= 100V About 1MΩ
mA input 10μA <= Span current <= 200μA About 50Ω
200μA < Span current <= 50mA About 10Ω
Thermocouple input About 8MΩ

MAXIMUM COMMON MODE VOLTAGE:
250VAC

COMMON MODE REJECTION RATIO:

More than 150dB

SERIES MODE REJECTION RATIO:

More than 50dB

INSULATION RESISTANCE:

500VDC, 20M or more between measuring terminals and protective conductor terminal
1000VDC, 20Ω or more between power terminals and protective conductor terminal
1000VDC, 20Ω or more between measuring terminals and power terminals

WITHSTAND VOLTAGE:

500VAC, 1 mm. between measuring terminals and protective conductor terminal
1000VAC (100V line)/1500VAC (200V line), 1 mm. between power terminals and protective conductor terminal
1000VAC (100V line)/1500VAC (200V line), 1 mm. between measuring terminals and power terminals

ILLUMINATION:

With/without select-off function Without fluorescent lamp
12-point repetition With fluorescent lamp

POWER CONSUMPTION: About 30VA

*Option

■ **TERMINAL BOARD**

EH □ 26-01

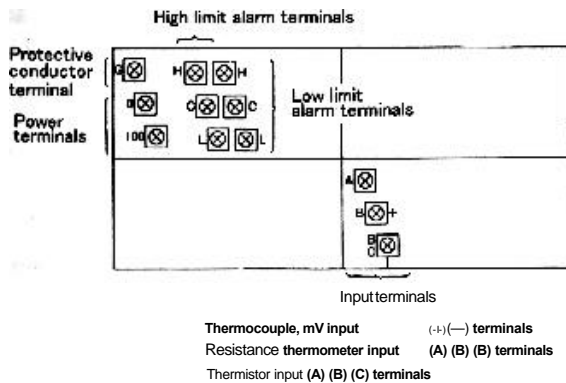

EH826-24□, EH126-24 □

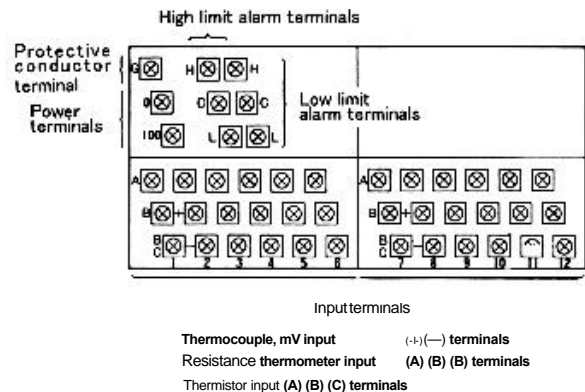

EH □ 36-12

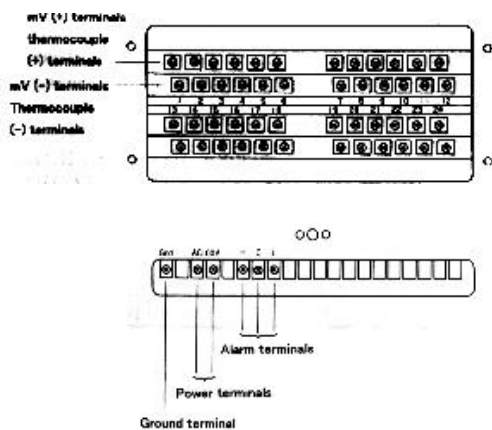

EH236-24□, EH336-24 □

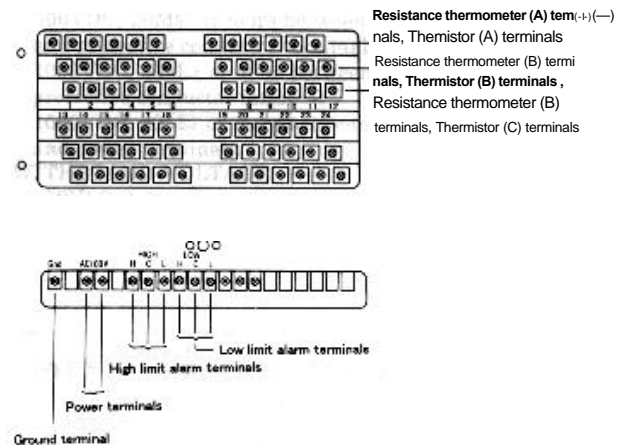

■ STANDARD SCALE

Input		Standard scale		
Thermocouple	R	0 to 1200 (20, 10) 400 to 1600 (10)	0 to 1400(20, 10) 700 to 1400(5)	0 to 1600 (20) 800 to 1600 (10)
	B	0 to 1800 (20, 10) *1		
	E	0 to 150(1)	0 to 200 (2)	0 to 300 (5, 2)
		0 to 400(5)	0 to 500 (5)	0 to 1200 (20)
		0 to 800(10) -100 to 200(2)	0 to 1000 (10) 100 to 250 (2, 1)	0 to 1200(10) 600 to 1200(5)
	J	0 to 150(1) -50 to 150(2)	0 to 200(2)	0 to 300(2)
0 to 200(2) 0 to 600(5)		0 to 300 (5, 2)	0 to 400 (5)	
	0 to 150(1) 0 to 300(5, 2) -50 to 150(2)	0 to 150(2, 1) -50 to 50(1) -50 to 200(2)	0 to 200 (2) -50 to 100 (2, 1) -100 to 200 (2)	

Input	Standard scale		
mV	0 to 5(0.05) -5to5(0.1) 0 toV(0.01V)	0 to 10(0.1) 1 to 5(0.05V)	0 to 100(1)
Res I stance Thermometer Pt 100	0 to 50(0.5) 0 to 200(2) 0 to 400(5) -40 to 80(1) -50 to 150(2) 100 to 250(1)	0 to 100(1) 0 to 250(2) 0 to 500(5) -50 to 50(1) -100 to 50(1)	0 to 150(1,2) 0 to 300(5, 2) -20 to 80(1) -50 to 100(2) 50 to 100(0.5)
Thermistor	0 to 100(1)	0 to 200(2)	-50 to 50(1)
Linear	0 to 100		

Unit °C, Unit mV for mV input only.

There are two kinds of characteristic scale and linear scale for thermocouple input and resistance thermometer input. If not specified, the recorder delivered is with a characteristic scale. A characteristic scale is provided for thermistor input. Parenthesized () figures show one division. Example: (20, 10) means 20°C for characteristic scale and 10°C for linear scale.

*1 In case of linear scale, the calibration of 400 to 1800°C is linear. One division of 400°C is 20°C for non-linear part under 200 to 400°C, 50°C for 100 to 200°C and 100°C for 0 to 100°C.

■ EXTERNAL DIMENSIONS

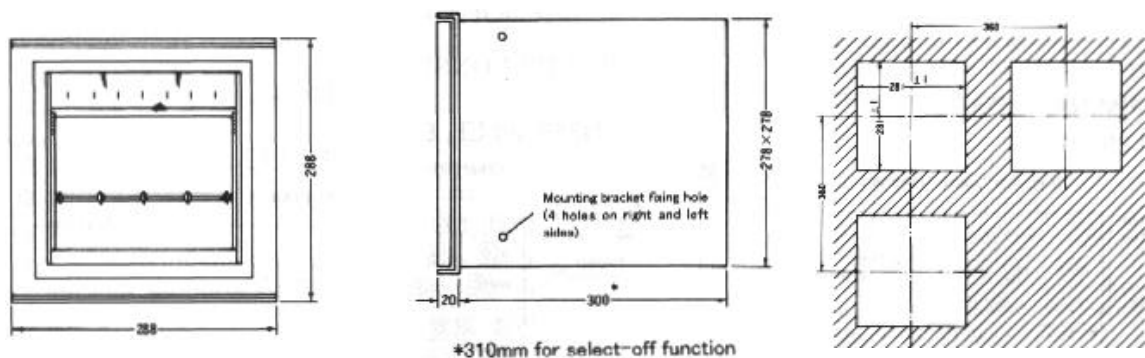

Unit : mm

Specifications subject to change without notice. Original 2000.12

CHINO CORPORATION

32-8, KUMANO-CHO, ITABASHI-KU, TOKYO 173-8632

PHONE: +81-3-3956-2171

FAX: +81-3-3956-0915

E-mail: inter@chino.co.jp

Website: http://www.chino.co.jp